



INSTRUCTION MANUAL

VHF FM REPEATER

IC-FR5000

UHF FM REPEATER

IC-FR6000

IC-FR6000-L



IMPORTANT

READ THIS INSTRUCTION MANUAL CAREFULLY before attempting to operate the repeater.

SAVE THIS INSTRUCTION MANUAL— This manual contains important safety and operating instructions for the IC-FR5000/IC-FR6000/IC-FR6000-L VHF/UHF FM REPEATERS.

PRECAUTIONS

⚠ WARNING HIGH VOLTAGE! NEVER attach an antenna or internal antenna connector during transmission. This may result in an electrical shock or burn.

⚠ WARNING HIGH VOLTAGE! NEVER install the antenna at any place that person touch the antenna easily during transmission. This may result in an electrical shock or burn.

⚠ WARNING! NEVER apply AC to the DC power receptacle on the repeater rear panel. This could cause a fire or damage the repeater.

⚠ WARNING! NEVER apply more than 16 V DC, such as a 24 V battery, to the DC power receptacle on the repeater rear panel. This could cause a fire or damage the repeater.

⚠ WARNING! NEVER let metal, wire or other objects touch any internal part or connectors on the rear panel of the repeater. This may result in an electric shock.

CAUTION: NEVER expose the repeater to rain, snow or any liquids.

DO NOT use or place the repeater in areas with temperatures below -30°C (-22°F) or above $+60^{\circ}\text{C}$ ($+140^{\circ}\text{F}$). Be aware that temperatures can exceed 80°C ($+176^{\circ}\text{F}$), resulting in permanent damage to the repeater if left there for extended periods.

DO NOT place the repeater in excessively dusty environments or in direct sunlight.

DO NOT put anything on top of the repeater. This will obstruct heat dissipation.

EXPLICIT DEFINITIONS

WORD	DEFINITION
⚠ WARNING!	Personal injury, fire hazard or electric shock may occur.
CAUTION	Equipment damage may occur.
NOTE	If disregarded, inconvenience only. No risk of personal injury, fire or electric shock.

Place the repeater in a secure place to avoid inadvertent use by children.

BE CAREFUL! The heatsink will become hot when operating the repeater continuously for long periods.

BE CAREFUL! If a linear amplifier is connected, set the repeater's RF output power to less than the linear amplifier's maximum input level, otherwise, the linear amplifier will be damaged.

Use Icom microphones only (optional). Other manufacturer's microphones have different pin assignments, and connection to the repeater may damage the repeater.

Approved Icom optional equipment is designed for optimal performance when used with an Icom repeater. Icom is not responsible for the destruction or damage to an Icom repeater in the event the Icom repeater is used with equipment that is not manufactured or approved by Icom.

For U.S.A. only

CAUTION: Changes or modifications to this repeater, not expressly approved by Icom Inc., could void your authority to operate this repeater under FCC regulations.

Icom, Icom Inc. and the Icom logo are registered trademarks of Icom Incorporated (Japan) in Japan, the United States, the United Kingdom, Germany, France, Spain, Russia and/or other countries.
All other products or brands are registered trademarks or trademarks of their respective holders.

SAFETY TRAINING INFORMATION



Your Icom radio generates RF electromagnetic energy during transmit mode. This radio is designed for and classified as “Occupational Use Only,” meaning it must be used only during the course of employment by individuals aware of the hazards, and the ways to minimize such hazards.

This radio is **NOT** intended for use by the “General Population” in an uncontrolled environment.



To ensure that your exposure to RF electromagnetic energy is within the FCC allowable limits for occupational use, always adhere to the following guidelines:

- **DO NOT** operate the radio without a proper antenna attached, as this may damage the radio and may also cause you to exceed FCC RF exposure limits. A proper antenna is the antenna supplied with this radio by the manufacturer or an antenna specifically authorized by the manufacturer for use with this radio.
- **DO NOT** transmit for more than 50% of total radio use time (“50% duty cycle”). Transmitting more than 50% of the time can cause FCC RF exposure compliance requirements to be exceeded. The radio is transmitting when the “TX indicator” lights red. You can cause the radio to transmit by pressing the “PTT” switch.

Electromagnetic Interference/Compatibility

During transmissions, your Icom radio generates RF energy that can possibly cause interference with other devices or systems. To avoid such interference, turn off the radio in areas where signs are posted to do so. **DO NOT** operate the transmitter in areas that are sensitive to electromagnetic radiation such as hospitals, aircraft, and blasting sites.

FOR CLASS B UNINTENTIONAL RADIATORS

This equipment has been tested and found to comply with the limits for a Class B digital device, pursuant to part 15 of the FCC Rules. These limits are designed to provide reasonable protection against harmful interference in a residential installation. This equipment generates, uses and can radiate radio frequency energy and, if not installed and used in accordance with the instructions, may cause harmful interference to radio communications. However, there is no guarantee that interference will not occur in a particular installation.

If this equipment does cause harmful interference to radio or television reception, which can be determined by turning the equipment off and on, the user is encouraged to try to correct the interference by one or more of the following measures:

- Reorient or relocate the receiving antenna.
- Increase the separation between the equipment and receiver.
- Connect the equipment into an outlet on a circuit different from that to which the receiver is connected.
- Consult the dealer or an experienced radio/TV technician for help.

FORWARD

Thank you for purchasing this Icom repeater. The IC-FR5000/IC-FR6000/IC-FR6000-L VHF/UHF FM REPEATERS are designed and built with Icom's state of the art technology and craftsmanship. With proper care, this product should provide you with years of trouble-free operation.

We want to take a couple of moments of your time to thank you for making the IC-FR5000/IC-FR6000/IC-FR6000-L your repeater of choice, and hope you agree with Icom's philosophy of "technology first." Many hours of research and development went into the design of your IC-FR5000/IC-FR6000/IC-FR6000-L.

◆ FEATURES

○ Up to 2 channels operation

You can install a channel extension module (optional UR-FR5000/UR-FR6000) into a repeater. 2 channels can be operated as the repeater when a channel extension module is installed.

○ Built-in 5-Tone, DTMF encoder & decoder

Multiple signaling systems are equipped as standard. These systems are fully compatible with Icom F-series radios.

○ DTMF remote control capability

You can control the repeater from a remote location over the air or over a phone line with DTMF.

○ D-Sub 25 pin ACC port equipped

You can use the optional equipment via the D-sub 25 pin ACC port equipped on the repeater's rear panel.

○ On-line control and Digital Trunking operation

The on-line control and digital trunking operation are available when the optional UC-FR5000 TRUNKING/NETWORK CONTROLLER is installed into a repeater.

○ Other features

- Wide frequency coverage
 - <VHF>
IC-FR5000 : 136 to 174 MHz
 - <UHF>
IC-FR6000/IC-FR6000-L
: 350 to 400 MHz,
400 to 470 MHz,
450 to 512 MHz,
450 to 520 MHz
- PC programmable
- 19 inch rack mount
- Optional Voice Scrambler Unit (UT-109R/UT-110R) for base operating mode

SUPPLIED ACCESSORIES

The following accessories are supplied.

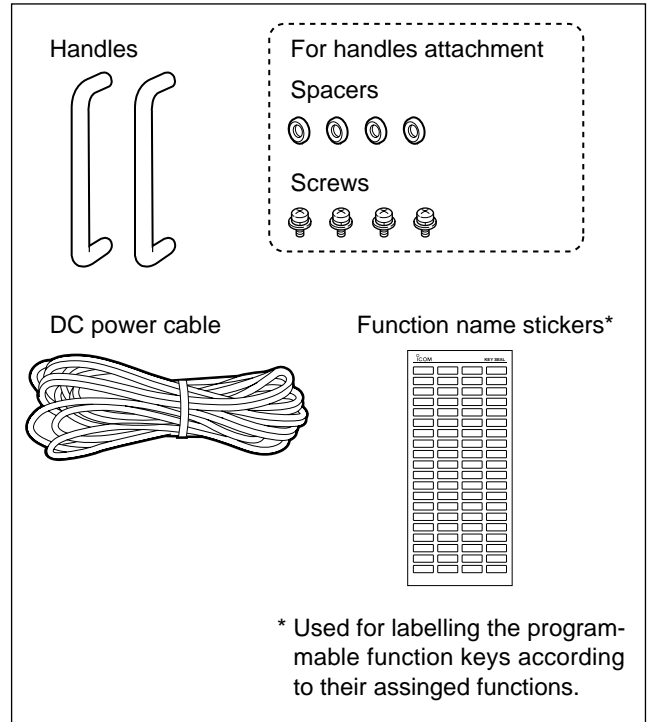
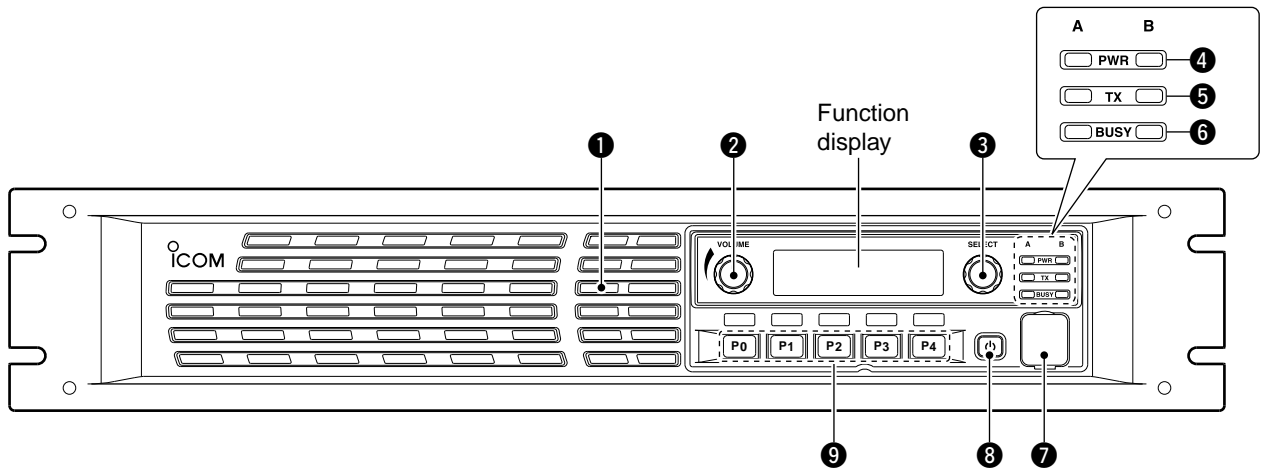

TABLE OF CONTENTS

IMPORTANT	i	3 OPERATION	7
EXPLICIT DEFINITIONS	i	■ Receiving and transmitting.....	7
PRECAUTIONS	i	◇ Repeater operation	7
SAFETY TRAINING INFORMATION	ii	◇ Base station operation	7
FOR CLASS B UNINTENTIONAL RADIATORS	ii	4 MAINTENANCE	8
FORWARD	iii	■ Troubleshooting	8
SUPPLIED ACCESSORIES	iii	■ Fuse replacement	8
TABLE OF CONTENTS	iv	◇ Line fuse replacement.....	8
1 PANEL DESCRIPTION	1–3	5 OPTIONS	9
■ Front panel	1	6 ABOUT VOICE CODING TECHNOLOGY	10
◇ Function display	2		
■ Rear panel.....	2		
◇ Accessory connector	3		
2 INSTALLATION AND CONNECTIONS	4–6		
■ Unpacking	4		
■ Selecting a location	4		
■ Antenna connection	4		
■ Front panel connection.....	5		
■ Rear panel connection	5		
■ Power supply connection	6		
■ Mounting the repeater	6		
◇ Using the supplied handle.....	6		



Front panel



1 INTERNAL SPEAKER

Monitors received signals.

2 VOLUME CONTROL [VOLUME] (p. 7)

Adjusts the audio output level.

3 SELECTOR DIAL [SELECT]

Rotate to adjust the squelch threshold level, select the operating channel. (Depending on the pre-programmed condition.)

4 POWER INDICATOR [POWER]

➔ Lights green at 'A' module's indicator while the repeater power is turned ON.

When a channel extension module is installed:

➔ Lights green at the selected module indicator ('A' or 'B') while the repeater power is turned ON.

➔ Lights orange at the un-selected module indicator ('A' or 'B') while the repeater power is turned ON.

5 TRANSMIT INDICATOR [TX]

Lights red while transmitting.

6 BUSY INDICATOR [BUSY]

Lights green while receiving a signal or when the noise squelch is open.

About [PWR], [TX] and [BUSY] indicators:

'A' and 'B' modules indicators are available for these indications. 'A' module's indicator correspond to the original module, and 'B' module's indicator correspond to an extended module.

7 MICROPHONE CONNECTOR [MIC]

This 8-pin modular jack accepts the optional microphone.

KEEP the [MIC] connector cover attached to the repeater when the optional microphone is not used.

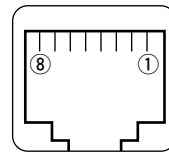

- ① +8 V DC output (Max. 15 mA)
- ② Output port for PC programming
- ③ NC
- ④ M PTT (Input port for TX control)
- ⑤ Microphone ground
- ⑥ Microphone input
- ⑦ Ground
- ⑧ Input port for PC programming

8 POWER SWITCH [POWER]

➔ Push to turn the repeater power ON.

➔ Push and hold for 3 sec. to turn the repeater power OFF.

When a channel extension module is installed:

➔ While the repeater power is turned ON, push to select the desired module to operate the repeater as the base station.

- The power indicator of the selected module unit lights green.

9 DEALER-PROGRAMMABLE KEYS

Desired functions can be programmed independently by your dealer.

Ask your dealer for details.

- Because these keys are programmable, the functions of these keys are unique to each unit.

◇ **Function display**

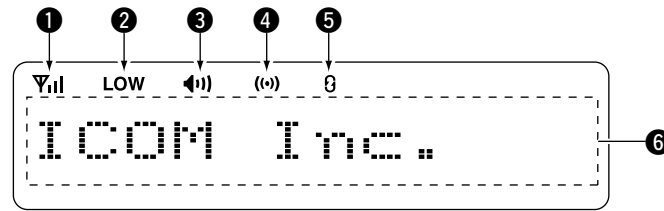

1 SIGNAL STRENGTH INDICATOR

Indicates relative signal strength level.

2 LOW POWER INDICATOR

Appears when low output power is selected.

3 AUDIBLE INDICATOR

Appears when the channel is in the 'audible' (unmute) condition.

4 COMPANDER INDICATOR

Appears when the compander function is activated.

5 SCRAMBLER/ENCRYPTION INDICATOR

Appears when the voice scrambler/encryption function is activated.

6 ALPHANUMERIC DISPLAY

Shows a variety of text or code information.

■ **Rear panel**

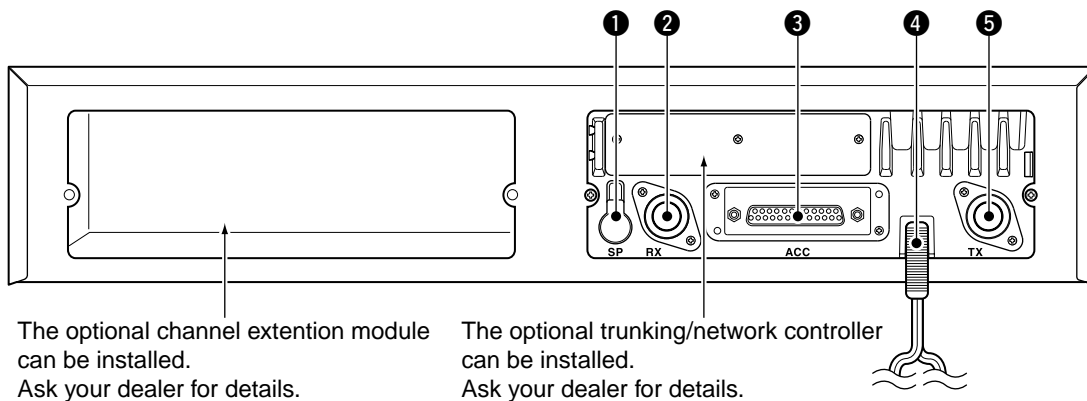

1 EXTERNAL SPEAKER CONNECTOR [SP]

Connect the optional SP-22.

2 RECEIVE ANTENNA CONNECTOR [RX]

Connects a receive antenna (impedance: 50 Ω) and inputs receiving signals.

3 ACCESSORY CONNECTOR [ACC]

Connects to the accessory connector.

- See p. 3 for accessory connector information.

4 DC POWER RECEPTACLE

Connects the supplied DC power cable from this connector to an external 13.6 V DC power supply.

5 TRANSMIT ANTENNA CONNECTOR [TX]

Connects a transmit antenna (impedance: 50 Ω) and outputs transmit signals.

1 PANEL DESCRIPTION



◆ Accessory connector

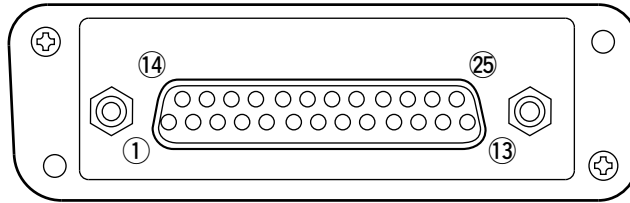

Pin No.	Pin Name	Description	Specification
1	NC	No connection	—
2	TXD	Output terminal for serial communication data.	—
3	RXD	Input terminal for serial communication data.	—
4	RTS	Output terminal for request-to-send data.	—
5	CTS	Input terminal for clear-to-send data.	—
6	NC	No connection	—
7	GND	Serial/digital signal ground	—
8	MOD IN	Modulator input from an external terminal unit.	Input level: 300 mV rms
9	DISC OUT	Output terminal for AF signals from the AF detector circuit. Output level is fixed, regardless of [AF] control.	Output level: 300 mV rms
10	EXT. D/A	The desired function can be assigned.* (Default: Null)	—
11	VCC	13.6 V DC output	Output current: Less than 1 A
12	EXT. A/D	Customize A/D input (Not used)	—
13	NC	No connection	—
14	GND	Ground	—
15	EXT./O 15	The desired function can be assigned.* (Default: Null)	+5 V pull up, Active=L
16	EXT./O 16	The desired function can be assigned.* (Default: P0 Monitor Output)	+5 V pull up, Active=L
17	EXT./O 17	The desired function can be assigned.* (Default: Busy Output)	+5 V pull up, Active=L
18	EXT./O 18	The desired function can be assigned.* (Default: Null)	+5 V pull up, Active=L
19	EXT./O 19	The desired function can be assigned.* (Default: EPTT Input)	+5 V pull up, Active=L
20	DATA IN	Input terminal for data.	—
21	EXT./O 21	The desired function can be assigned.* (Default: Analog Audible Output)	+5 V pull up, Active=L
22	AF OUT	The AF detector Output.	—
23	EXT./O 23	The desired function can be assigned.* (Default: Mic Mute Output)	+5 V pull up, Active=L
24	EXT./O 24	The desired function can be assigned.* (Default: Null)	+5 V pull up, Active=L
25	EXT./O 25	The desired function can be assigned.* (Default: Mic Hanger Output)	+5 V pull up, Active=L

* The desired function can be assigned using the optional CS-FR5000 CLONING SOFTWARE. Ask your dealer for details.

■ Unpacking

After unpacking, immediately report any damage to the delivering carrier or dealer. Keep the shipping cartons.

For a description and a diagram of accessory equipment included with the repeater, see 'SUPPLIED ACCESSORIES' on p. iii of this manual.

■ Selecting a location

Select a location for the repeater that allows adequate air circulation, free from extreme heat, cold, or vibrations, and away from TV sets, TV antenna elements, radios and other electromagnetic sources.

■ Antenna connection

For radio communications, the antenna is a critical component, along with output power and sensitivity. Select antenna(s), such as a well-matched 50 Ω antenna, and feedline. 1.5:1 or better of Voltage Standing Wave Ratio (VSWR) is recommended for desired band. Of course, the transmission line should be a coaxial cable.

CAUTION: Protect repeater from lightning by using a lightning arrestor.

NOTE: There are many publications that describe proper antennas and their installation. Check with your local dealer for more information and recommendations.

1
2

TYPE-N CONNECTOR INSTALLATION EXAMPLE

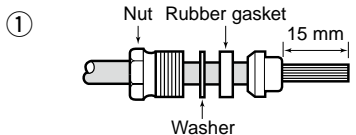

Slide the nut, flat washer, rubber gasket and clamp over the coaxial cable, then cut the end of the cable evenly.

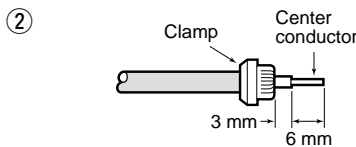

Strip the cable and fold the braid back over the clamp.

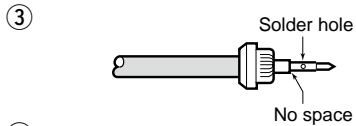

Soft solder the center conductor. Install the center conductor pin and solder it.

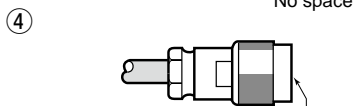

Carefully slide the plug body into place aligning the center conductor pin on the cable. Tighten the nut onto the plug body.

Be sure the center conductor is the same height as the plug body.

15 mm (19/32 in) 6 mm (1/4 in) 3 mm (1/8 in)

■ Front panel connection

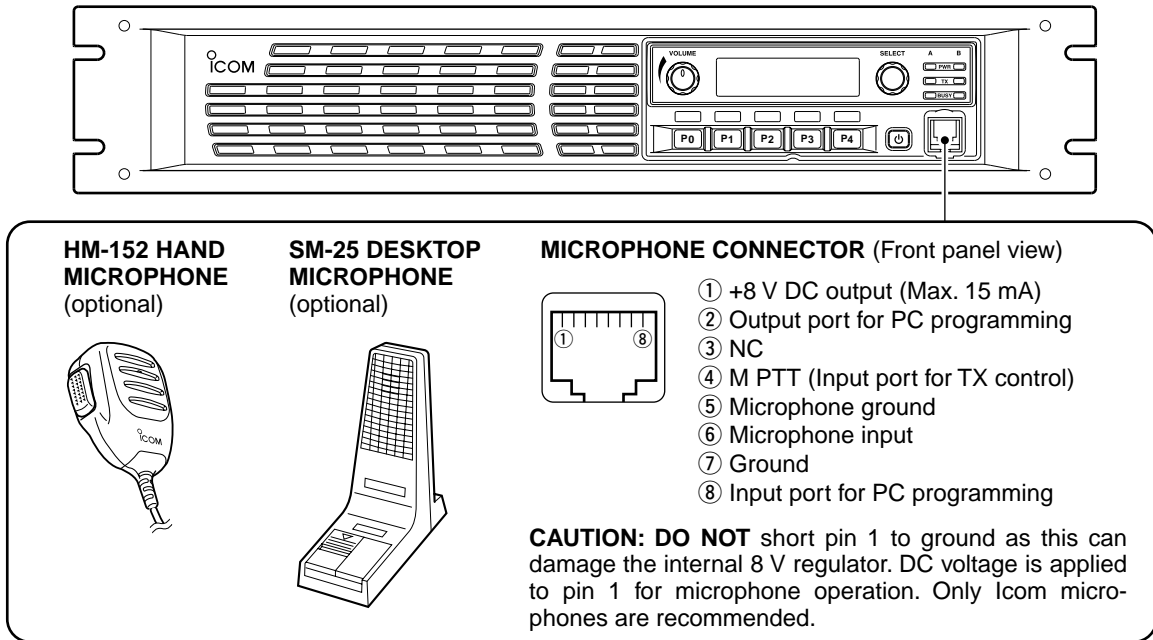

■ Rear panel connection

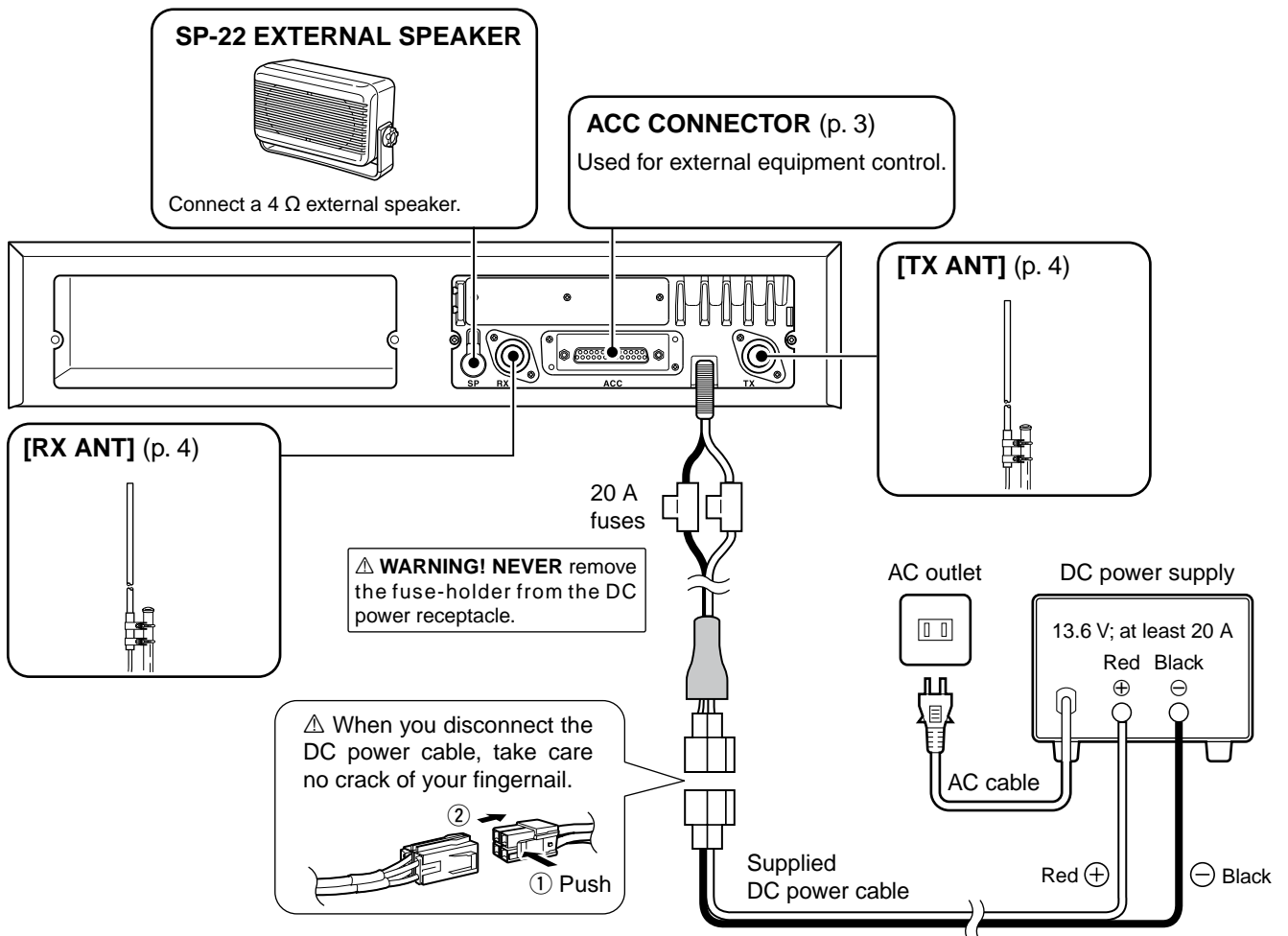

■ Power supply connection

Make sure the repeater's power is turned OFF when connecting a DC power cable.

CAUTION: Voltages greater than 16 V DC will damage the repeater. Check the source voltage before connecting the power cable.

■ Mounting the repeater

◇ Using the supplied handle

The supplied handles are available for mounting the repeater into a 19 inch rack. The handles can be installed to the repeater's front panel.

- ① Attach the supplied handles to both sides of the repeater's front panel with the spacers, then tighten the screws as below.

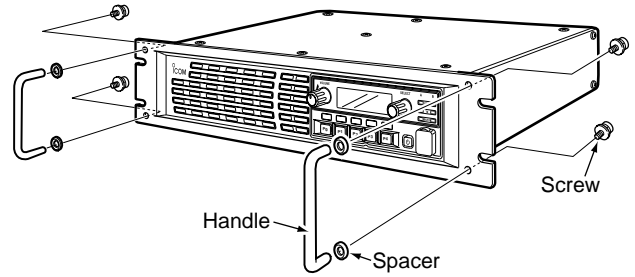

- ② The completed installation should look like as below.

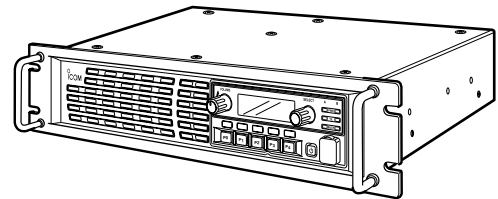

■ Receiving and transmitting

◇ Repeater operation

Ask your dealer for details of the repeater's programming.

- When the power is turned ON, the **[PWR]** indicator lights green. (p. 1)
- The **[TX]** and **[BUSY]** indicators light simultaneously while transmitting/receiving a signal.
 - The **[TX]** indicator lights red.
 - The **[BUSY]** indicator lights green.

NOTE: A power amplifier protector is built-in to the repeater. The protector is activated when the repeater temperature becomes extremely high due to the frequently access to the repeater to reduce the transmit output power level. The output power will return to the normal level when the repeater has cooled down.

◇ Base station operation

Receiving

- ① Push **[POWER]** to turn the power ON.
- ② Set the audio and squelch levels.
 - Rotate **[SELECT]***¹ fully counterclockwise in advance.
 - Rotate **[VOLUME]** to adjust the audio output level.
 - Rotate **[SELECT]***¹ clockwise until the noise disappears.
- ③ Push **[CH Up]***² or **[CH Down]***² to select the desired channel.
 - When receiving a signal, the **[BUSY]** indicator lights green and audio is emitted from the speaker.
 - Further adjustment of **[VOLUME]** to a comfortable listening level may be necessary at this point.

*¹ When the [SQL Level Up/Down] key function is assigned to [SELECT].

*² When the [CH Up]/[CH Down] key functions are assigned.

Transmitting

- ① Take the microphone off hook.
- ② Wait for the channel to become clear.
- ③ Push and hold **[PTT]** to transmit, then speak into the microphone at your normal voice level.
- ④ Release **[PTT]** to receive.

IMPORTANT:

To maximize the audio quality of the transmitted signal:

1. Pause briefly after pushing **[PTT]**.
2. Hold the microphone 5 to 10 cm (2 to 4 inch) from your mouth, then speak into the microphone at a normal voice level.

■ Troubleshooting

The following chart is designed to help you correct problems which are not equipment malfunctions.

If you are unable to locate the cause of a problem or solve it through the use of this chart, contact your nearest Icom Dealer or Service Center.

PROBLEM	POSSIBLE CAUSE	SOLUTION	REF.
Power does not come on when [POWER] is pushed.	<ul style="list-style-type: none"> • DC power cable is improperly connected. • Fuse is blown. 	<ul style="list-style-type: none"> • Re-connect the DC power cable correctly. • Check for the cause, then replace the fuse with a spare one. 	pp. 5, 6 p. 8
No sound comes from the speaker.	<ul style="list-style-type: none"> • Volume level is too low. • The squelch is closed. • The audio mute function is activated. • A selective call or squelch function is activated such as 5-tone call or tone squelch. • The front speaker is set to OFF. 	<ul style="list-style-type: none"> • Rotate [VOLUME] clockwise to obtain a suitable listening level. • While in base operating mode, rotate [SELECT] to counterclockwise to open the squelch. (When the [SQL Level Up/Down] key function is assigned to [SELECT].) • Push [MONI] (if assigned) to turn the audio mute function OFF. • Turn the appropriate function OFF. • Turn the front speaker ON using the optional CS-FR5000 CLONING SOFTWARE. Ask your dealer for details. 	p. 7 p. 7 – – –
Sensitivity is low and only strong signals are audible.	<ul style="list-style-type: none"> • Antenna feedline or the antenna connector has a poor contact or is short-circuited. 	<ul style="list-style-type: none"> • Check and re-connect (or replace if necessary), the antenna feedline or antenna connector. 	p. 5
Received audio is unclear or distorted.	<ul style="list-style-type: none"> • Optional voice scrambler is turned OFF. • Scrambler code is not set correctly. 	<ul style="list-style-type: none"> • Turn the optional voice scrambler ON. • Reset the scrambler code. 	– –
Output power is too low.	<ul style="list-style-type: none"> • Output power is set to Low. • Power amplifier protection circuit is activated. 	<ul style="list-style-type: none"> • Push [HIGH/LOW] (if assigned) to select the High power. • Cool down the repeater or stop accessing to the repeater until it has cooled down. 	– –
No contact possible with another station.	<ul style="list-style-type: none"> • The other station is using tone squelch. • While in base operating mode, the repeater is set to duplex. 	<ul style="list-style-type: none"> • Turn the tone squelch function ON. • Set the repeater to simplex, when other transceiver is set to simplex. 	– –

■ Fuse replacement

If a fuse blows or the repeater stops functioning, try to find the source of the problem, and then replace the damaged fuse with a new, rated fuse.

CAUTION: DISCONNECT the DC power cable from the repeater. Otherwise, there is danger of electric shock and/or equipment damage.

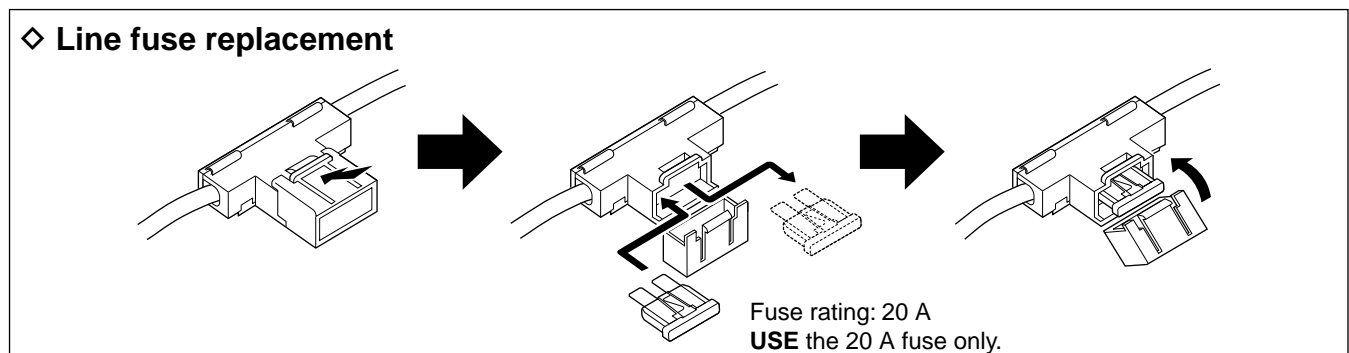

3
4

- **SP-22** EXTERNAL SPEAKER

Compact and easy-to-install.

Input impedance : 4 Ω

Max. input power : 5 W

- **HM-152** HAND MICROPHONE

- **SM-25** DESKTOP MICROPHONE

- **UR-FR5000/UR-FR6000** CHANNEL EXTENSION MODULES

- **UC-FR5000** TRUNKING/NETWORK CONTROLLER

- **UT-109R** VOICE SCRAMBLER UNIT

Non-rolling type (max. 32 codes).

- **UT-110R** VOICE SCRAMBLER UNIT

Rolling type (max. 1020 codes).

* The scrambler systems of the UT-109R and UT-110R are not compatible with each other.

Some options may not be available in some countries.
Please ask your dealer for details.

The AMBE+2™ voice coding Technology embodied in this product is protected by intellectual property rights including patent rights, copyrights and trade secrets of Digital Voice Systems, Inc. This voice coding Technology is licensed solely for use within this Communications Equipment. The user of this Technology is explicitly prohibited from attempting to extract, remove, decompile, reverse engineer, or disassemble the Object Code, or in any other way convert the Object Code into a human-readable form. U.S. Patent Nos. #5,870,405, #5,826,222, #5,754,974, #5,701,390, #5,715,365, #5,649,050, #5,630,011, #5,581,656, #5,517,511, #5,491,772, #5,247,579, #5,226,084 and #5,195,166.

Count on us!

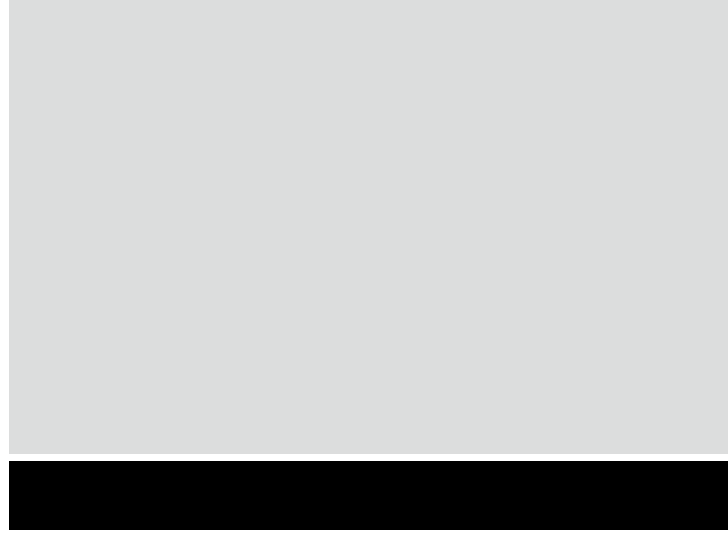

Accessory Connector Addendum

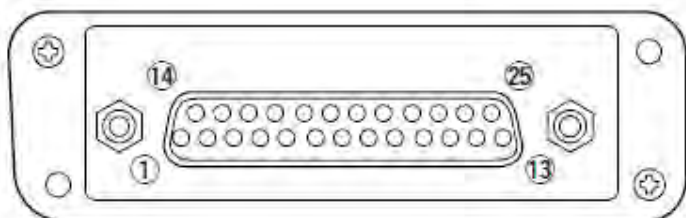

Pin No.	Pin Name	Description	Specification
1	NC	No connection	--
2	TXD	Output terminal for serial communication data. PC connector only.	--
3	RXD	Input terminal for serial communication data. PC connector only.	--
4	RTS	Output terminal for request-to-send data. PC Connector only.	--
5	CTS	Input terminal for clear-to-send data.	--
6	NC	No Connection	--
7	GND	Serial/digital signal ground	--
8	MOD IN	Modulator input from an external terminal unit.	- Input level: 300 mV rms 848mV P-P - Input for AF from 300Hz or more - Connection for MSK modem - Input impedance: approx. 2.7kΩ
9	DISC OUT	Output terminal for AF signals from the AF detector circuit. Output level is fixed, regardless of [AF] control.	Output level: 300 mV rms 848mV P-P Output from detector circuit - Buffer output - When receiving a signal with 60% modulation, outputs 300mVrms.
10	EXT. D/A	The desired function can be assigned in the programming software. (Default: Null)	--
11	VCC	13.6 V DC output	Output current: Less than 1 A
12	EXT. A/D	Customize A/D input (Not used)	--
13	NC	No Connection	--
14	GND	Ground	--
15	EXT.I/O 15	The desired function can be assigned in the programming software. (Default: Null)	+5 V pull up, Active = L
16	EXT.I/O 16	The desired function can be assigned in the programming software. (Default: P0 Monitor Output)	+5 V pull up, Active = L
17	EXT.I/O 17	The desired function can be assigned in the programming software. (Default: Busy Output)	+5 V pull up, Active = L
18	EXT.I/O 18	The desired function can be assigned in the programming software. (Default: Null)	+5 V pull up, Active = L
19	EXT.I/O 19	The desired function can be assigned in the programming software. (Default: EPTT Input)	+5 V pull up, Active = L

Pin No.	Pin Name	Description	Specification
20	DATA IN	Input terminal for data	Data input for AF from 2kHz or more - Bypasses pre-emphasis circuit - Input impedance approx 47k Ω - Approx 60% modulation when applying 300mVrms input (848mV P-P)
21	EXT.I/O 21	The desired function can be assigned in the programming software. (Default: Analog Audible Output)	+5 V pull up, Active = L
22	AF OUT	The AF detector output	AF output with fixed level (does not follow AF volume position) - Signal after de-emphasis circuit - Buffer output - When receiving a signal with 60% modulation, outputs 300mVrms (848mV P-P)
23	EXT.I/O 23	The desired function can be assigned in the programming software. (Default: Mic Mute Output)	+5 V pull up, Active = L
24	EXT.I/O 24	The desired function can be assigned in the programming software. (Default: Null)	+5 V pull up, Active = L
25	EXT.I/O 25	The desired function can be assigned in the programming software. (Default: Mic Hanger Output)	+5 V pull up, Active = L